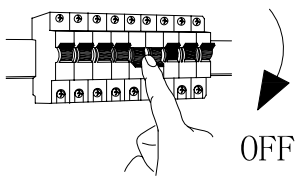
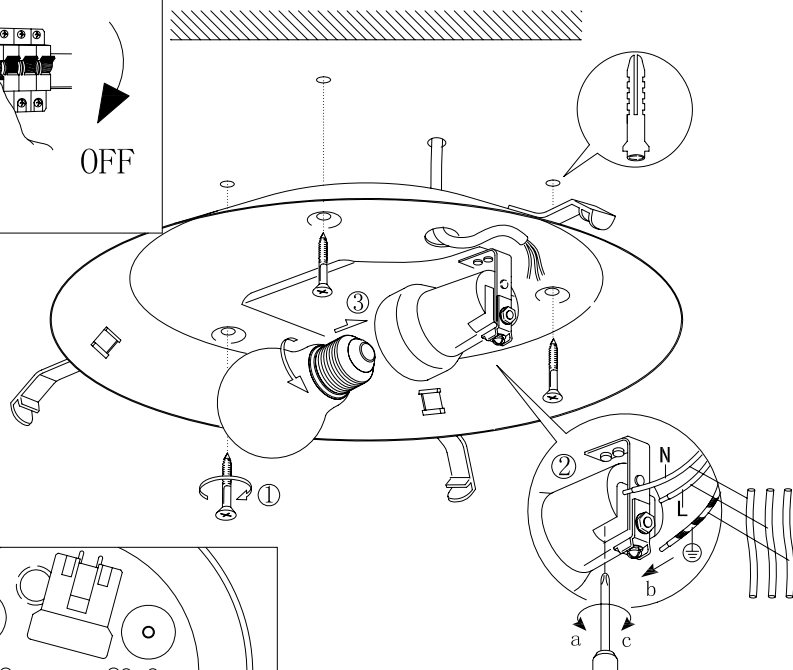
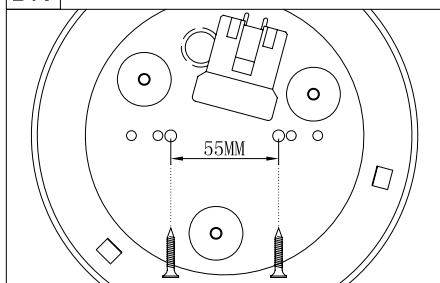
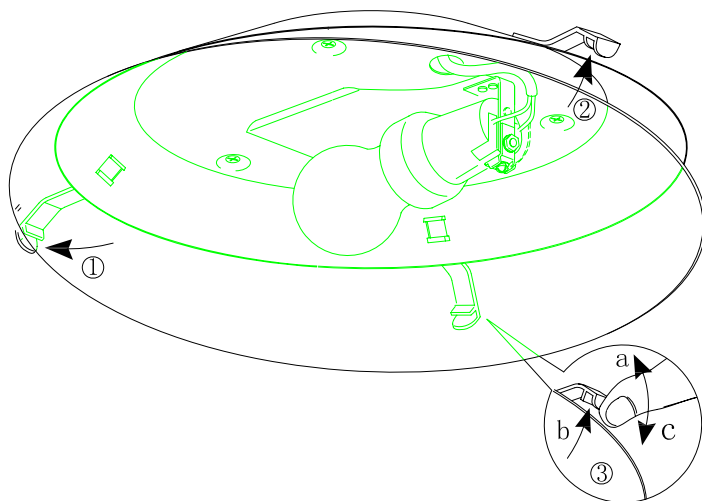
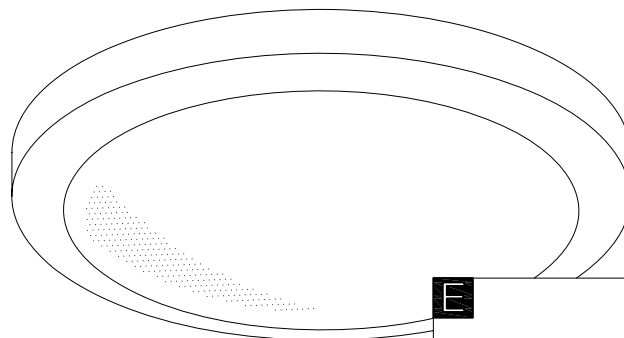
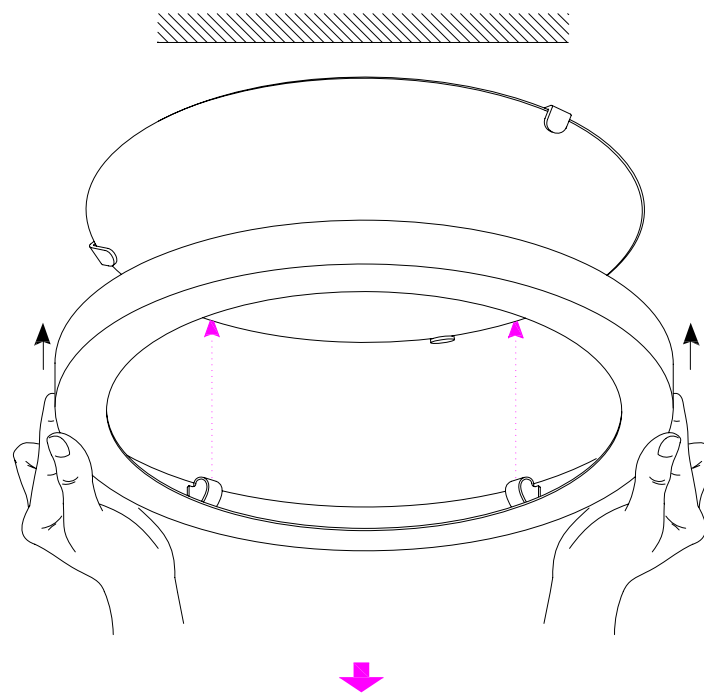
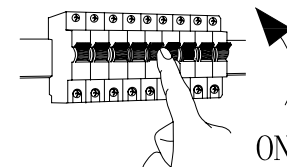

A**B****DK**

For montering på eksisterende installation med 1,5 mm²

**C****D****E****ON**